

MTU-8A

Quick Start Guide for MT

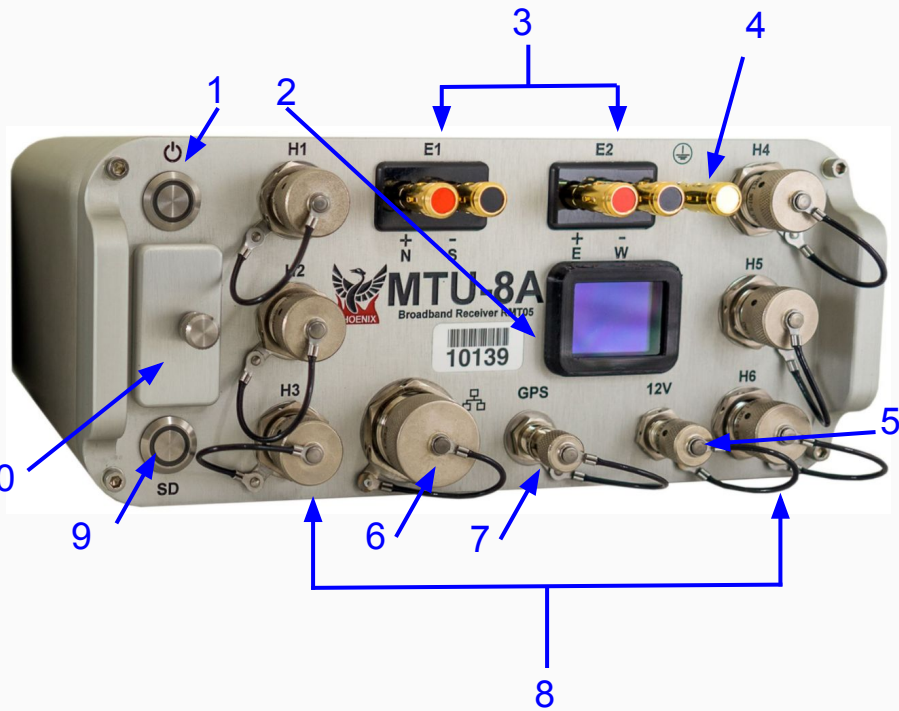

MTU-8A (components)	2
MTU-8A	3
MT acquisition.....	4
Electric Channel Settings	5
Magnetic Channel Settings	6
Mixing Magnetic Sensor Types	7
Saving a Configuration File	8
MTU-8A Connections	9
SD Card - Recording Data	10
Stopping a recording	11
Importing - Field QC	12
Field QC	13
Process MT Data	14
Recording Details	15
Contact Support	16



Components

1	Power/Record button and indicator
2	Display
3	E1 (Ex) electrode connectors
3	E2 (Ey) electrode connectors
4	Ground electrode connector
5	12V DC power input
6	LAN connector
7	GPS antenna connector
8	H1 - H4 (Hx) magnetic sensor connector H2 - H5 (Hy) magnetic sensor connector H3 - H6 (Hz) magnetic sensor connector
9	SD card button and indicator
10	SD card slot and cover

MTU-8A

The MTU-8A UMT (Ultra-Wideband MT) system, supersedes older separate AMT, MT, BMT and Long Period MT systems.

With 6 Magnetic channels, there is no longer any need for expensive, separate deployments of different systems to capture the necessary spectrum; simplifying and saving money on procurement, training, operation and maintenance.

Designed with versatility in mind, the 8-channel MTU-8A UMT receiver is compatible with all Phoenix magnetic sensors and common three-axis fluxgate sensors in the market.

This manual is intended for MT operations. The MTU-8A can also be used for CSAMT recordings. For more information on CSAMT consult the [CSAMT Operation manual](#) (DAA31).



Creating a Configuration File for MT Acquisition

1. Click **Prepare** and select the **Receiver type** as **MTU-8A** and click the **MT** button

2. Select the **Schedule**

2.1. **Manual** or **Automatic Start**

2.2. For a specific schedule, select **Single Shot**, **Daily** or **Weekly**, and set the desired time and date, and **Save**

- To add additional schedules, select **Add Schedule** and define the additional times and/or dates

3. Ethernet port (see the [Networking Settings manual](#))

4. Define the **Channel Settings**

5. Define the **Receiver Settings**

- **Sampling Mode**
- **Sampling Rate**

6. **Configuration Layout**

1 → Prepare

2 → Schedule

2.1 → Manual

2.2 → Single Shot

3 → MTU-8A Geophysical Receiver

4 → Channel Settings

5 → Receiver Settings

6 → Configuration layout

This section is used for inputting the parameters and instrument details that will be used for the recording

To use the magnetic sensor data from a different recording or use a remote reference, all recordings **must** have a matching Sampling Mode and Sampling Rates. Otherwise, EMpower will not allow to process the data using borrowed channels or remote reference

Creating a Configuration File - Electric Channel Settings

1. Select the **Electric** channel
2. **Enable** or **Disable** the channel(s)
 - Disable channels that you do not plan to use during the recording. This will save space on the SD card.
3. Select the desired Gain and Low Pass Filter (LPF)
 - For most applications, Normal Gain and 10 kHz Low Pass Filter are best
4. Type **distances** to the **electrodes** of this channel, if known
 - if not, they will need to be corrected later before processing the data

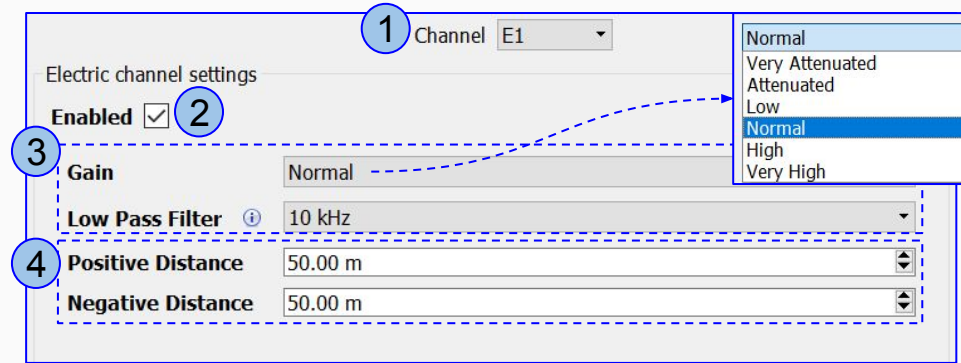

2. Some settings can be configured by using the right-click menu

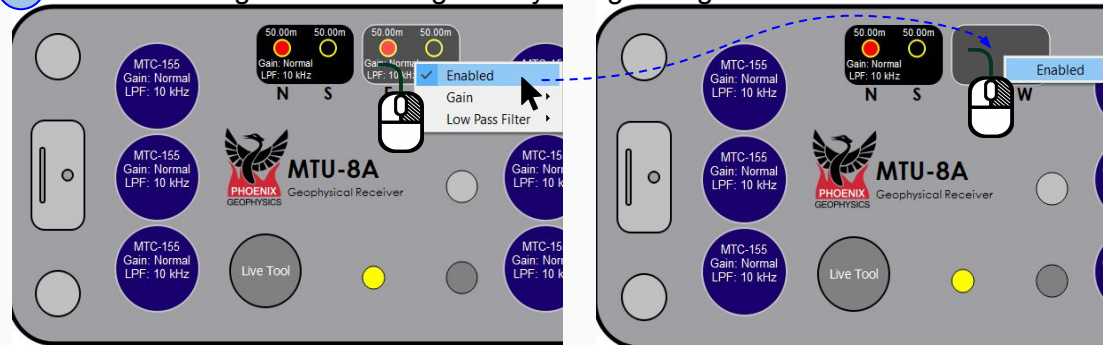

Creating a Configuration File - Magnetic Channel Settings

1. Select a **Magnetic** channel

2. **Enable or Disable** channel(s)

- Disable channels that are not meant to be used for recording data. This will save space on the SD card.

3. Select the correct **Sensor Type**

- If the sensor type is incorrect in the configuration file, the receiver will display a warning message. However, the recording will not be interrupted
- Mixing sensor types is possible (*Phoenix + Bartington / Lemi*) more details in the next page

4. Select the desired **Gain** and **LPF**

- For most broadband applications with MTC-100 series sensors, Normal Gain and 10 kHz LPF are best

5. Type the **Serial Number** of the sensor if required

- There is no need to type serial number for sensors MTC-155/MTC-185, since it will be automatically detected by the receiver.
- For older sensors, type the serial number of each sensor. If you don't know this information in advance, keep field notes to add this information later, after the recording is imported into EMpower

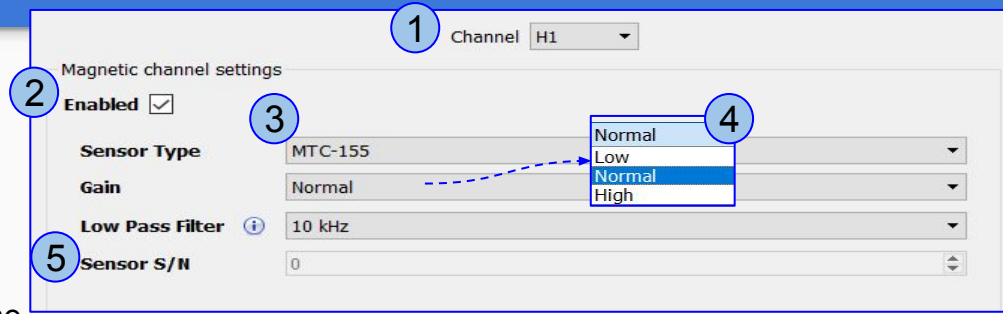

Some settings can be configured by using the right-click menu

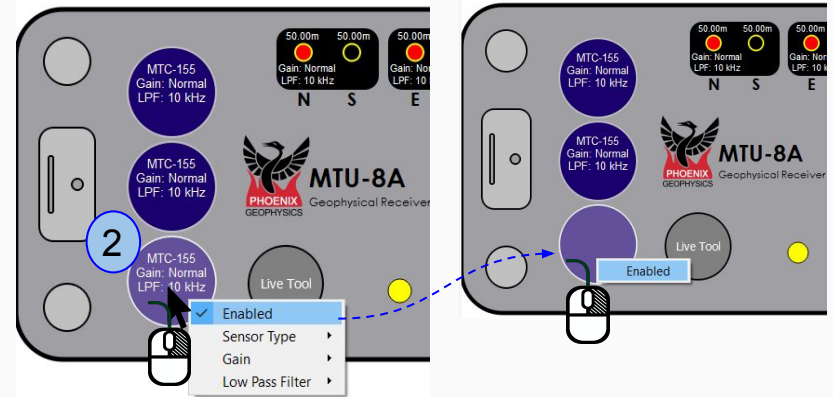

Mixing Magnetic Sensor Types

EMpower allows to mix different sensor types, with sets divided into two groups of three, H1-H3 and H4-H6. It is possible to work with mixed groups of Phoenix's new generation, Phoenix legacy, Bartington, or Lemi sensors.

1. Select the sensor type for H1-H3 and H4-H6

1.1. It is possible to work with a combination of Phoenix's new generation and legacy for
Example

H1-H3 MTC-50H+MTC-50H+MTC-185

H4-H6 MTC-150+MTC-155+MTC-80H

1.2. Lemi and Bartington works in groups of three sensors at the time, can't be mixed within the same group

2. Configure each magnetic channel as described in the previous slide

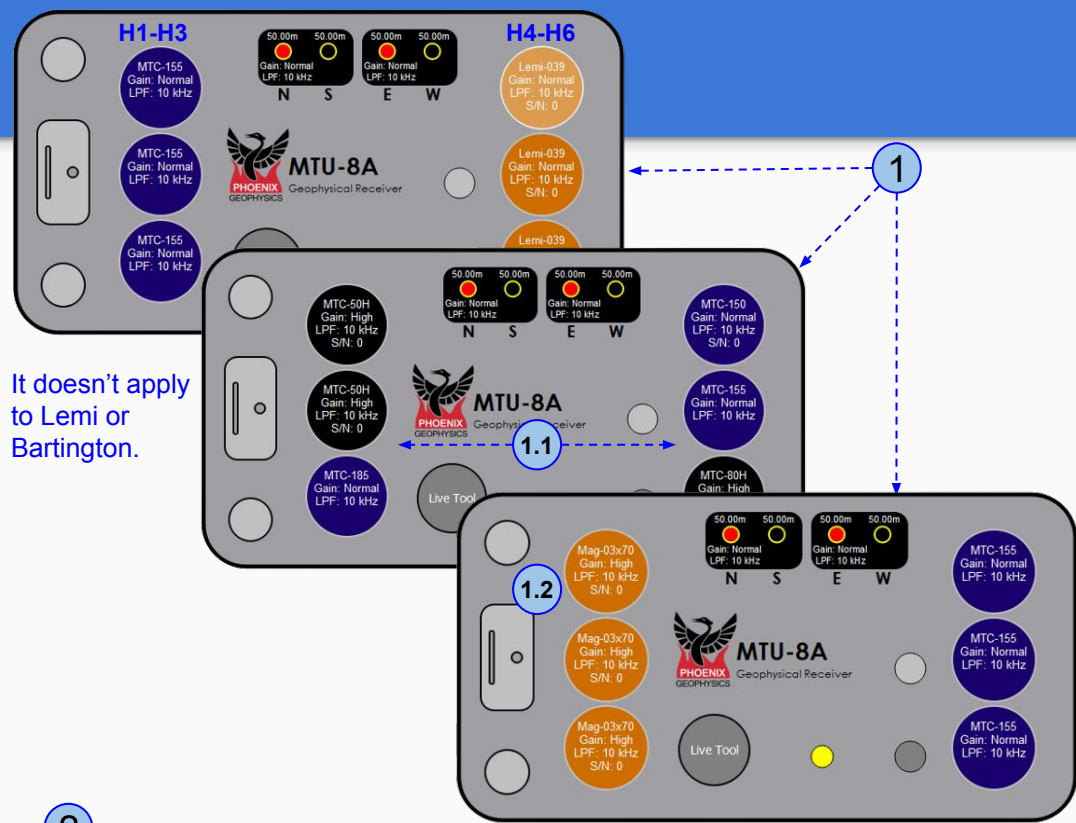

It doesn't apply to Lemi or Bartington.

2

Magnetic channel settings

Enabled

Sensor Type: Bartington Mag-13MS70 (BETA)

Gain: Normal

Low Pass Filter ⓘ: 10 kHz

Sensor S/N: 0

Saving a Configuration File

1. Insert the SD Card

- The computer must be equipped with an SD card slot or use a USB card reader

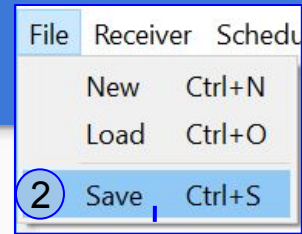

2. Click the **File** menu

- **Save** or **Ctrl+S**
- **Select the SD card**
- **EMpower** will automatically create the file **"config.json"**

3. Save the configuration file (**config.json**) in the root folder of the **SD card**

4. Open the file explorer

- Right click **SD card** drive
- **Select Eject** option
- **Pull out the SD Card**

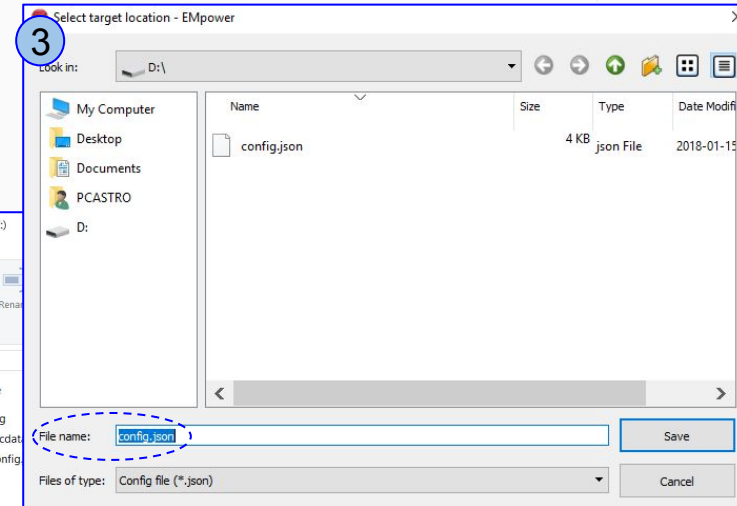
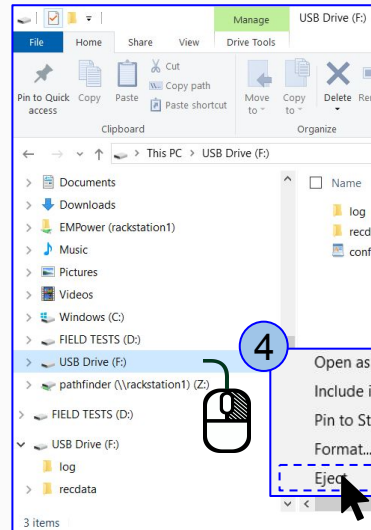

MTU-8A

Connections - Single site MT

Start by connecting:

1. Ground electrode
2. Electrodes to channel **E1**(Ex) (N+, S-) and channel **E2**(Ey) (E+, W-)
3. Magnetic sensors to channels **H1**(Hx), **H2**(Hy), **H3**(Hz), **H4**(Hx), **H5**(Hy), and **H6**(Hz) as required
4. GPS antenna
5. 12V DC Power Source
6. Network connector



i In the field, it is often most efficient to connect the components to the receiver following the order on the right



SD Card - Recording Data



**For any problem with the SD Card, check the Troubleshooting manual*



Indicators

-   *Rapid, equal pulses*
-  *Solid color / Off*

The receiver auto-detects serial and model for magnetic sensors of the new generation (MTC-155/185). The information about the sensor is updated on the receiver screen only at power on and right after each recording starts.

2

Briefly press and release the power button

Starting Acquiring GPS Ready



SD



2.1

Automatic Start

The recording starts automatically according to the schedule



SD

Recording



3

Briefly press and release the power button

Ready

Channels
Detection

Recording



SD



Stopping a recording

1. Press the **Power** button briefly and release to stop recording
 - Wait until both LEDs are steady blue
2. Turn off the receiver by pressing the **Power** button for a few seconds, until the **LEDs** will flash red
 - Wait until both **LEDs** turn off
3. Eject the **SD card**
 - Press the **SD card** and release, pull the **SD card**



Indicators

■■■■■■■ *Rapid, equal pulses*

■■■■■■■ *Solid color / Off*

- 1 Briefly press and release the power button

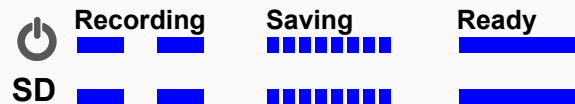

- 2 Keep pressing the power button 3 sec and release



- 3



Importing - Field QC

1. Click the **Field QC** button
2. Select **View data**
3. Select the **SD card**
 - The recording creates two folders, log and recdata
4. Open the **recdata** folder
 - Select the recording file
 - Click **Choose**

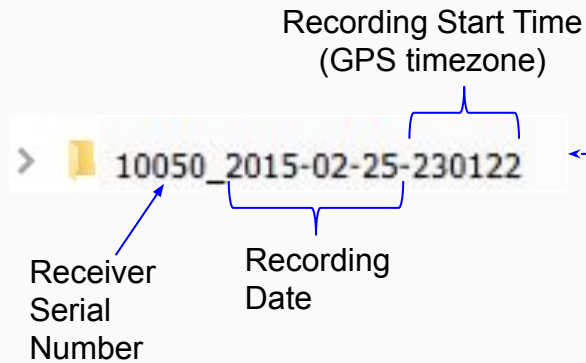
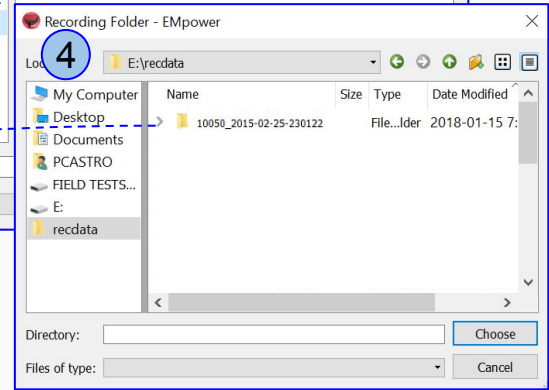
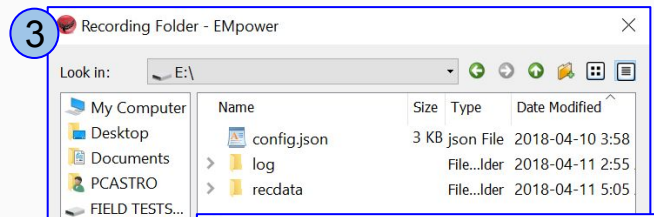
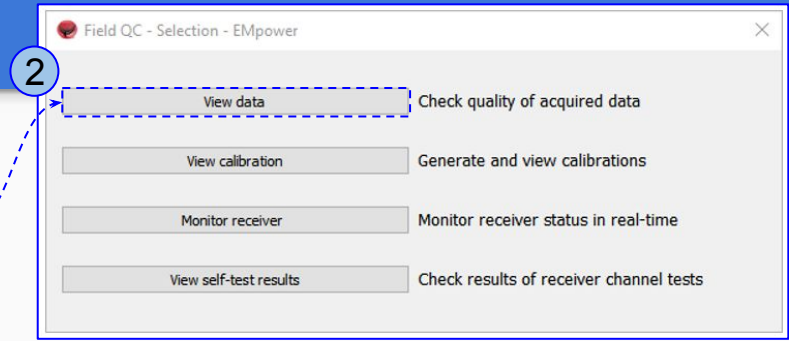
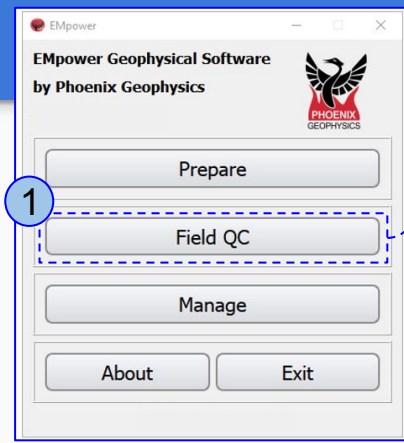

1. Review the **Recording Information**
2. Review the Electrode **Resistance** values and make the necessary corrections
 - Electrode **Distance (m) to GND**
 - **Polarity**
 - **E Azimuth**
 - **External Filter**
3. Ensure that the magnetic sensors were detected and make the necessary corrections
 - **Serial #**
 - **Polarity**
 - **H1-H3 Azimuth**
 - **H4-H6 Azimuth**
4. **View Recording Details** (see page 16)
5. After reviewing the information, **Process** the data

Field QC - EPower

RD2 10050 Schedule Decimated + Raw AMTC-30 + MTC-50HL (8h 58m 39s)

Status: Approved Unapproved Rejected

Tools: Time Series | Spectra | **Process (Orthogonal)**

1 Recording Information

Recording ID: 10050_2015-02-25-230122

Warning: There were warnings detected in H1, H4, H5, H6. View warning icons for more details.

Start time: Feb 25 2015 15:01:23 (Local) Eastern Standard Time (GPS -08:00)

Duration: 8h 58m 39s

Survey name: Nevada February 2015 Milestone v0.18

Station name: RD2 10050 Schedule Decimated + Raw AMTC-30 + MTC-50HL

Operator(s): SW

Company name:

Layout Geometry: Orthogonal

Declination: 0.00°

Notes:

2 Electric Channels

Channel	Distance (m) to GND		Polarity	Resistance (Ω)		Gain	LPF [Hz]	DC [V]
	(+) N / E	(-) S / W		(+) N / E	(-) S / W			
E1	50.00	50.00	<input type="checkbox"/> Inverted	229.325	224.290	4 x 4 = x16	10000	-0.00023
E2	50.00	50.00	<input type="checkbox"/> Inverted	219.059	226.341	4 x 4 = x16	10000	0.019

E Azimuth: 0.00° External Filter: None

3 Magnetic Channels

Channel	Sensor	Detected	Serial #
H1	MTC-155	Not Present	0
H2	MTC-155	MTC-155	57404
H3	MTC-155	MTC-155	57408
H1-H3 Azimuth: 0.00°			
H4	MTC-50H	MTC-50	0
H5	MTC-50H	MTC-50	2683
H6	MTC-50H	MTC-50	0
H4-H6 Azimuth: 0.0°			

4 View Recording Details

5 This section can also be used to input additional field information if desired

Warning: The warning icon indicates that something might be wrong with the recording, review the recording information and make necessary changes if needed. Hover mouse pointer over the warning icon for more information.

Process Data

6. Select the local **Reference type** for the channels
7. Select the default group of magnetic channels to be used for processing
7.1. Or use the **Select Manually** button to choose specific channels, this can be done for both magnetic and electric channels
8. Define the segment of time series to be processed, select the **Start** and **End** date/time, or use the arrows to define the time period
9. Select the **electric power grid filter** that corresponds to the frequency carried by the power lines in the survey area (50Hz, 60Hz, or None)
10. Click the **Process** button
11. A live display of the resistivity curve will appear after a few seconds

Magnetic Channels

<input type="radio"/> Hx = H1 MTC-155 0	<input type="radio"/> Hx = H4 MTC-50H 0	<input type="radio"/> Hx = H2 2022-08-09T20:39:22Z
<input type="radio"/> Hy = H2 MTC-155 0	<input type="radio"/> Hy = H5 MTC-50H 0	<input checked="" type="radio"/> Hy = H3 2022-08-15T20:50:49Z
<input type="radio"/> Hz = H3 MTC-155 0	<input type="radio"/> Hz = H6 MTC-50H 0	<input type="radio"/> Hz = H5 2022-07-08T19:07:24Z

Reference type: **Magnetic**

Electric Channels

Use the following Ex = E1 Ey = E2

Manually selected Ex = E2 Ey = E1

Processing timeframe

Time zone: Site time zone: America/Toronto (GPS-04:00)

Start: 2022-07-08 15:07:25 End: 2022-07-08 16:16:32

Sunrise: 05:43 Sunset: 21:01 Duration: 1h 9m 7s

Electric power grid filter

50 Hz 60 Hz None

Channel Selection - ...

Ex <input checked="" type="radio"/> E1 <input type="radio"/> E2	Ey <input type="radio"/> E1 <input checked="" type="radio"/> E2
---	---

EMpower will process only 3 magnetic channels at the time

This resistivity curve can only be saved as image. It is purely for QC purposes

14

View Recording Details

Review that the following levels are within valid limits for quality control:

- 1. Battery Voltage
- 2. Internal Temperature
- 3. Number of Satellites
- 4. Saturated Frames for each channel
 - If saturation is not close to ~0%, review the channel configuration (see pages 5 - 7), the channel gain might be too high and/or there is artificial noise on your site
- 5. Time Series Levels for each channel

Recording Details: 10288_2019-09-04-042404 - EMpower

Recording Details
Recording ID: 10050_2015-02-25-230122
Survey Name: Nevada June 2022
Company Name: Phoenix Geophysics
Receiver Type: MTU-8A
Instrument Serial: 10296
Operator: EE7DFJT

Timing Details
Start Time: Jun 25 2022 14:01:31 (Local) Eastern Daylight Time
Stop Time: Jun 25 2022 15:07:59 (Local) Eastern Daylight Time
Duration: 1h 6m 28s
Latitude: 37.339°N
Longitude: 114.940°W
Altitude: 1359.33 m

Instrument Info
OS Version: v2.9.0.2
Motherboard Model: BMB01-I
Motherboard Serial: 0320DC
Battery: Low: 12.596 V, High: 12.678 V
Temperature: Low: 50°C, High: 51°C

Decimation
Recorded 2 seconds at 24000 samples/s every 30 seconds, and continuously at 150 samples/s

GPS Timing Card
Serial Number: 203205
Model: BTM01-I
Firmware Version: 00010029X
of Satellites: 9 - 15 satellites

Channels Details

Tag	Board S/N	Model	Firmware	Sat	Signal Ranges
1	E1	202327	BCM01-K	1001d	~0% - View
2	E2	202205	BCM01-K	1001d	~0% - View
3	H1	203220	BCM01-K	1001d	1.417% - View
4					0.387% - View

Callout 1: Battery Voltage
Graph showing Voltage (V) vs Time. Values range from approximately 12.32V to 12.67V.

Callout 2: Internal Temperature
Graph showing Temperature (°C) vs Time. Values fluctuate between approximately 24.8°C and 29.6°C.

Callout 3: Number of Satellites
Graph showing # of Satellites vs Time. Values fluctuate between approximately 10 and 15.

Callout 4: Saturated Frames - E1
Graph showing # of Saturated Frames vs Time. Values are mostly near 0, with some spikes up to 6.

Callout 5: Time Series Level - H1
Graph showing Signal [V] vs Time. Values fluctuate around 0V, with Maximum, Average, and Minimum lines indicated.



Please check out the [FAQs](#)

<https://phoenixgeophysics.freshdesk.com/>

Or email us at: support@phoenix-geophysics.com